



Quadro Indoor S/D

The comfort solution – no columns or any other barrier in the area of the doors

Area of application: residential buildings, hotels, office buildings,
single garages above ground, prefabricated garages

Both platforms are horizontally accessible.

- Load per platform max. 2000kg
- Load per wheel max. 500kg

Dimensions in cm.
The shown dimensions in the drawing are standard dimensions.

pit at front	pit at rear	inside height	car height below	car height above
170	165(170)	325	150	150
185	180(180)	340	165	155
185	180(185)	350	165	165
200	195(200)	350	180	150
200	195(200)	380	180	180

Vehicle data

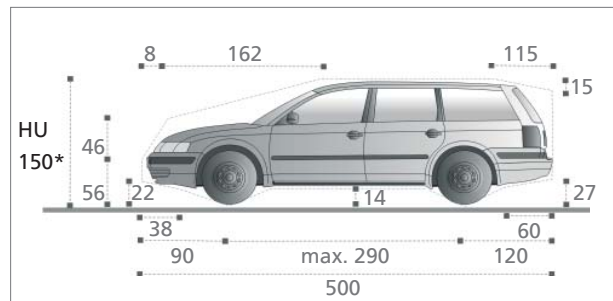
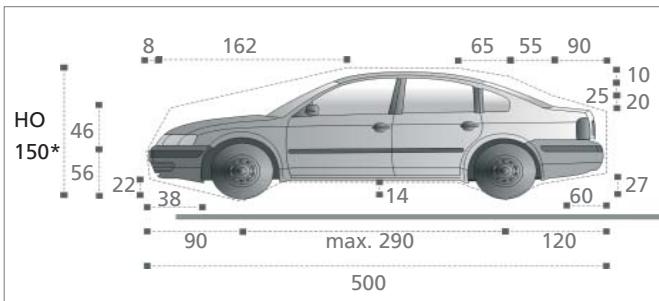

standard: car width max. 190cm, load per platform max. 2000kg, load per wheel max. 500kg

Note

Height of the car HO* and HU*: Alternative car height see table above. The total car height including roof rail and antenna fixture must not exceed the mentioned max. height.

Optional vehicle data

Car length: 510cm, load per platform: max. 2600kg, load per wheel max. 625kg; only with S-systems (single system for 2 cars): width of space: 250/260/270cm – total system width 280/290/300cm; pit length 540cm

Width dimensions • Garages

All dimensions are minimum dimensions. All dimensions in cm. Tolerances to the German Norm VOB part C (DIN 18330, 18331) and DIN 18202 are to be considered.

Note: Dimensions do not include the dimensions of the hydraulic unit. Dimensions of the hydraulic unit and the switch cabinet shown in page 4 below, are to be considered in the planning.

partition walls

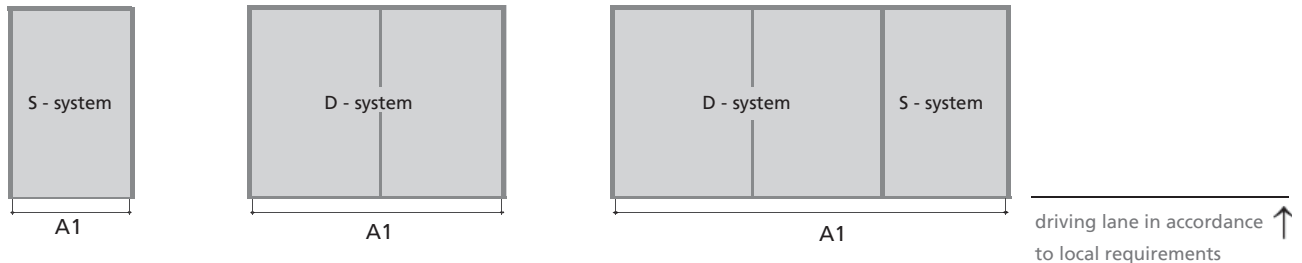

S-system for 2 cars

width A1	260	270	280
width*	230	240	250

* gives clear platform width

D-system for 4 cars

width A1	490	500	510	520	530
width*	460	470	480	490	500

* gives clear platform width

D- and S-system for 6 cars

width A1	750	780	810
width*	460/230	480/240	500/250

* gives clear platform width

building pillars in front of the pit

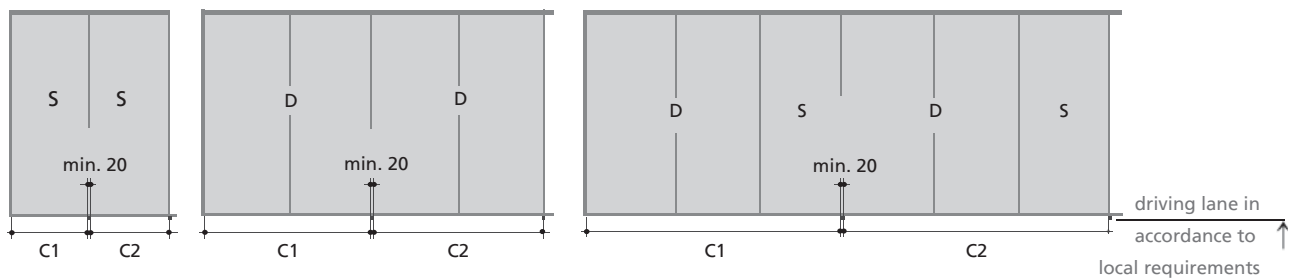

S-system for 2 cars

width C1	250	260	270
width C2	240	250	260
width*	230	240	250

* gives clear platform width

D-system for 4 cars

width C1	480	490	500	510	520
width C2	470	480	490	500	510
width*	460	470	480	490	500

* gives clear platform width

D- and S-system for 6 cars

width C1	740	770	800
width C2	730	760	790
width*	460/230	480/240	500/250

* gives clear platform width

Features in the scope of delivery



1 key-switch
2 emergency stop

Key switch

Key switch incl. emergency stop, dead man's control type with brief operating instructions and wiring to hydraulic unit.

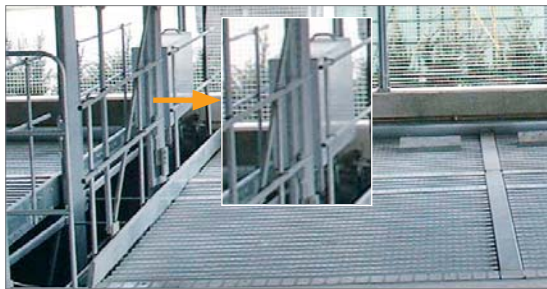

Hydraulic unit

Hydraulic unit "Silencio" with tubing and wiring to the installation. The oil submerged motor "Silencio" is extremely quiet and smooth running. The motor-pump assembly is sound absorbent.

Location

- between or behind two systems in the pit on a 2m high support, see picture above
- if there is no space between or behind the systems – wall-mounted
- single systems: power supply placed directly on the lower platform, in the front left side

Dimensions incl. switch cabinet

- 1 – 2 systems: 65cm x 25cm x 60cm
- 3 – 5 systems: 115cm x 25cm x 60cm

The hydraulic unit can be used for up to 5 Car Parking Systems.

Scope of supply

S/D-system with 2 platforms, 4 telescope columns with hydraulic cylinders, lifting carriage

Width of parking space

Width of parking space 230cm and pit depth 170/165cm as standard

Safety devices

- synchronizing device for safe operation even with unequal load distribution on the platform
- entering wedge for easy drive-in and parking
- locking device prevents lowering by pipe breakage
- fixation of the car parking systems and hydraulic unit with HD-anchors, wiring and impact dowels
- railings to avoid risk of falling onto the platform, insofar as necessary

Note: Safety guards against shearing and squeezing have priority and must be provided by the Buyer.

Protection against corrosion

Corrosion protection version „Classic“ of driving plates by continuous line-galvanizing to DIN EN 10142/10143. Corrosion protection version „Classic Plus“ of driving plates by line-galvanizing to DIN EN 10142/10143 (depending on the market specific needs zinc coated and powder coated sheet metal included in the scope of supply).



Driving plates

Driving plates as trapezoidal sheet plates as standard, options see "Extra Equipment".

Extra Equipment and Options



- button lifting
- button lowering
- emergency stop
- key switch with key
- interlock

Berlin control system/Fire brigade

Interlocked key switch, removal of the key only in the upper basic position.



Driving plates

Alu-bulb-plate in the walking area even more user friendly when walking and driving.



Catwalks

Positioning on the left side of the parking space even more comfortable, when walking to the driver door. 1,5mm zinc sheet, surface area coined. The catwalks are screwed with the drive plates, available with corrosion protection „Classic“ or „Classic Plus“.

Dimensions: approx. 350cm x 31/41 cm (L x W)

Width of parking space

Width of parking space 240cm and 250cm is recommended for even more vehicle comfort

Vehicle weight

Optional vehicle weight: up to 2600kg

Additional sound insulation

- structure-borne noise package to comply with DIN 4109 and adherence to sound insulation-measure Rw ´57
- sound insulation hood to minimize airborne sound

Hydraulic

- HVLP-oil for high fluctuations in temperature

Installation of garage gates

- ramp when door facing is not available to install the door slide rail, pit length must be 535cm, at the minimum

Protection against corrosion

- Corrosion protection version „Premium“ of driving plates by individual piece-galvanizing to DIN ISO 1461
- Corrosion protection version „Premium Plus“ of driving plates by individual piece-galvanizing to DIN ISO 1461 and coating of the top surfaces

Tips

- We recommend a maintenance contract.
- Attendance and cleaning according to recommendations or in regular intervals.

Interfaces to be performed by the Buyer

Foundation

Foundation works exactly to size, clean and dry is to be completed by the start of the installation. Bonded anchors for high foundation requirements shall be provided if necessary, available also as option.

Foundation plan

	single system	double system
F1	15 kN	27.5 kN
F4	+/- 1 kN	+/- 1 kN
F5	10 kN	10 kN

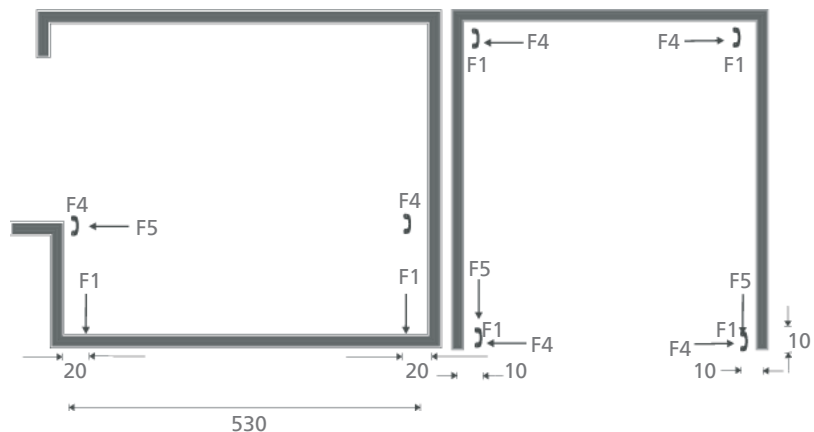

The pit must be executed in compliance with the designated forces. The forces and loads are transferred to the foundation by bearing plates with an area of 150cm². The bearing plates are fixed with metal expansion anchors. The drill hole depth is approx. 14 cm. All walls in the pit below the entrance level must be of concrete.

Electrical data

- supply line to main switch 5 x 4mm² or according to local requirements, fuse protection 3 x 25 amp, slow
- lockable main switch, near to hydraulic unit but outside of the pit, completed at the beginning of installation, height approx. 180cm above entrance level (color requirements to EN 60204-1, 10.7.4, color red)
- capacity of the hydraulic unit: 400volt, 50hz, three-phase motor 6,0 kW
- electrical potential equalisation (foundation grounding steel-construction to VDE 0100 T410)

General costumers duties

- level surface (L x W) 50cm x 20cm to attach the control panel, close to the system, outside the operational platform area
- safeguarding according to DIN EN 294
- lighting according to DIN 67528, illumination of parking lots and buildings for parking
- at the edge of the pit a 10cm wide, yellow-black marking according to ISO 3864
- wall opening 10cm x 10cm for hydraulic- and electrical lines in case of intermediate walls
- compliance with installation requirements as per quotation

lockable main switch



safeguarding according to DIN EN 294



marking pit edge



Width dimensions • Garages with doors

single system for 2 cars

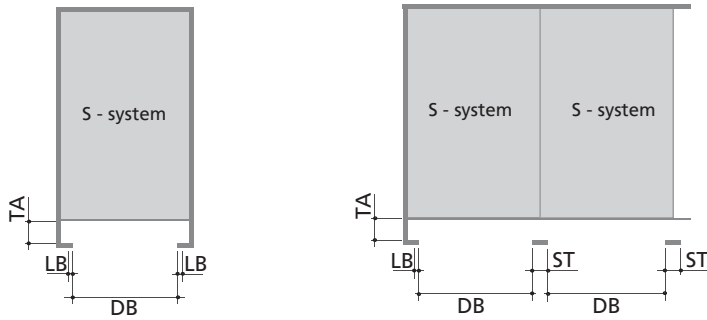

TA = seat-engaging surface for doors
The dimensions must be agreed with the door manufacturer on site.

width of parking space	door entrance width DB	reveal LB	pillar ST
230	237 ⁵	12 ⁵	25
240	250	12 ⁵	25
250	250	15	30

double system for 4 cars

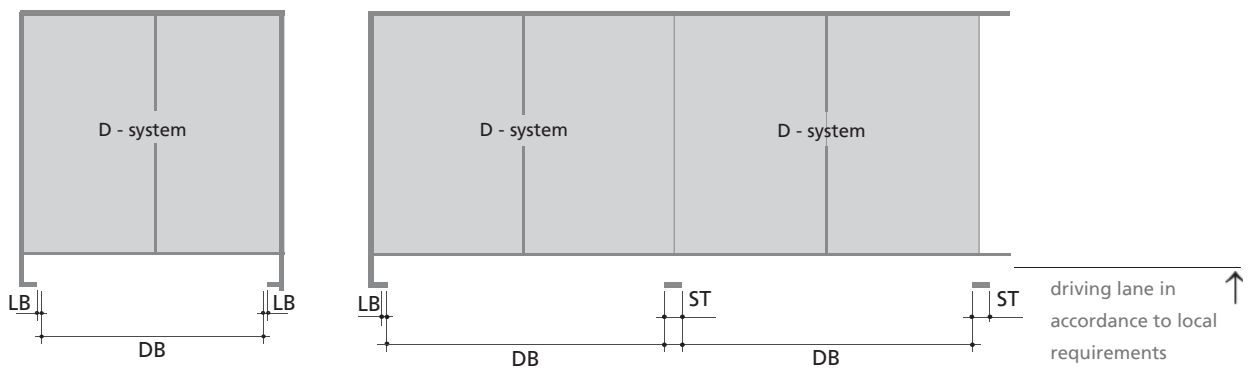

width of parking space	door entrance width DB	reveal LB	pillar ST
460	460	15	30
470	475	12 ⁵	25
480	475	17 ⁵	35
490	500	12 ⁵	25
500	500	15	30

Electrical data

Installation diagram

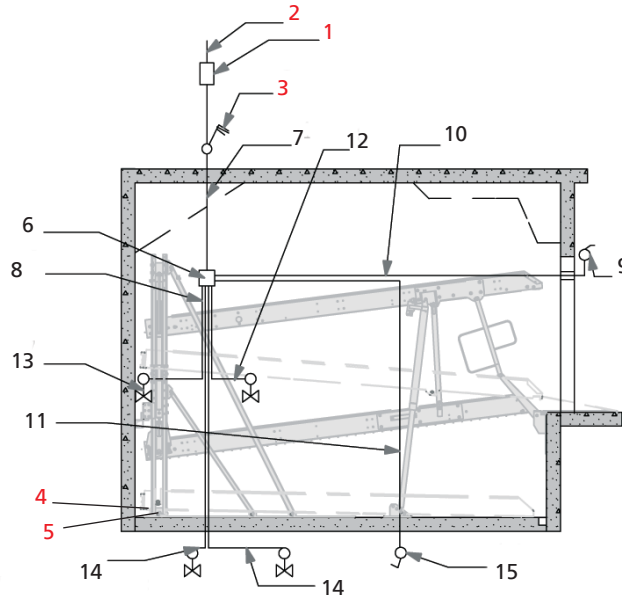

Figure: Car Parking System with inclined accessible. Specifications are also apply to systems with horizontal accessible platforms.

Item	Performance	Quantity	Designation	Positioning	Frequency
1	on site	1	fuse or automatic circuit 3 x 25 amp slow to DIN VDE 0100 part 430	in the feed cable	1 per hydr. unit
2	on site	1	supply line 5 G 4,0mm ² or according to local requirements	feed cable to main switch	1 per hydr. unit
3	on site	1	lockable main switch	near to hydraulic unit	1 per hydr. unit
4	on site	each 10m	foundation earth connector	corner pit floor/ rear wall	
5	on site	1	potential equalisation to DIN EN 60204	from foundation earth connector to the system	1 per hydr. unit
6	Nussbaum	1	hydraulic unit with three-phase motor 400volt, 50hz 6kW		
7	Nussbaum	1	supply line 5 G 4,0mm ² with marked wires and protective conductor	from main switch to hydraulic unit	1 per hydr. unit
8	Nussbaum	1	control line 2x1		
9	Nussbaum	1	control element with emergency stop		
10	Nussbaum	1	control line 4G1		
11	Nussbaum	1	control line 4G1		
12	Nussbaum	1	control line 2x1		
13	Nussbaum	1	hydraulic valve lifting and lowering		
14	Nussbaum	1	hydraulic valve lifting and lowering by installation in ranks		
15	Nussbaum	1	control element for each further system		

The items 6 – 15 are included in the scope of supply, unless otherwise specified in the offer/order.