

## 25 (1") square drive

25 1" 25 1"

## Sets 25 (1") METRIC







25 1"

D 21 EMU-10  
SOCKET SET 1"

15 pieces

- > With forged, tempered UD profile sockets, hand-operated
- > With accessories made from GEDORE vanadium steel 31CrV3
- > With reversible lever change ratchet
- > In GEDORE blue sheet steel case
- > Dimensions: 765 x 289 x 105 mm

25  
1"  
mm

Ratchet	Sockets	Accessories		Code	No.
 U-10 K <b>2193 U-10 K</b>	 <b>D 21</b> 36 41 46 50 55 60 65 70 75 80	 <b>2190-8</b> -16  <b>2187 G</b>  <b>2187 K</b>	31.4	6181600	D 21 EMU-10







## Sets 25 (1") INCH

D 21 EAU-10  
SOCKET SET 1"

15 pieces

- > With forged, tempered UD profile sockets, hand-operated
- > With accessories made from GEDORE vanadium steel 31CrV3
- > With reversible lever change ratchet
- > In GEDORE blue sheet steel case
- > Dimensions: 765 x 289 x 105 mm

25  
1"  
"AF

Ratchet	Sockets	Accessories		Code	No.
 U-10 K <b>2193 U-10 K</b>	 <b>D 21</b> 1.1/2 1.5/8 1.7/8 2 2.1/16 2.1/4 2.3/8 2.9/16 2.3/4 3"	 <b>2190-8</b> -16  <b>2187 G</b>  <b>2187 K</b>	34.9	6181790	D 21 EAU-10

## Ratchets 25 (1")

2193 U-10  
REVERSIBLE RATCHET 1"

- › Particularly for the demanding use experienced in industry and with utility vehicles
- › Acc. to DIN 3122, ISO 3315
- › With recessed lever change, locks in middle position
- › Return angle 11.25 degrees

- › Push-fit bar handle no. 2187 G
- › For hand-operated sockets and accessories with square drive as per DIN 3120 - D 25, ISO 1174 with locking pin
- › GEDORE vanadium steel 31CrV3, chrome-plated



Execution	1"	25	°	l mm	mm	kg	Code	No.
<b>complete</b>	1	25	11,25	810	61.5	5.210	6180550	2193 U-10
<b>head only</b>	1	25		184	61.5	1.980	6196120	2193 U-10 K
<b>tommy bar</b>				700		3.275	6195900	2187 G

2193 U-3  
REVERSIBLE RATCHET 1"

- › Especially for working in confined spaces, as with utility vehicles
- › Acc. to DIN 3122, ISO 3315
- › With non-slip metal disc change, fine-toothed (72 teeth) and robust
- › Return angle 5 degrees

- › Push-fit tube handle
- › For hand-operated sockets and accessories with square drive as per DIN 3120 - D 25, ISO 1174, with locking pin
- › GEDORE vanadium steel 31CrV3, chrome-plated

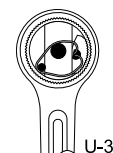

Execution	1"	25	°	l mm	mm	kg	Code	No.
<b>complete</b>	1	25	5	720	76	4.160	6180630	2193 U-3
<b>head only</b>	1	25				2.000	1637487	2193 U-3 K
<b>tube</b>						2.175	1382500	2193 Z/17

2193 Z-94  
RATCHET HANDLE WITH COUPLER 1"

- › Used throughout industry and the automotive world
- › Acc. to DIN 3122, ISO 3315
- › With square coupler, medium-fine toothed, extremely rugged
- › Return angle 9 degrees

- › Push-fit tube handle
- › For hand-operated sockets and accessories with square drive as per DIN 3120 - D 25, ISO 1174 with locking pin
- › GEDORE vanadium steel 31CrV3, chrome-plated

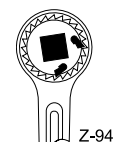

Execution	1"	25	°	l mm	mm	kg	Code	No.
<b>complete</b>	1	25	9	720	41	4.115	6181520	2193 Z-94
<b>head only</b>	1	25				1.175	1493779	2193 Z K
<b>tube</b>						2.175	1382500	2193 Z/17

Sockets 25 (1")

D 21 (MM)  
SOCKET 1"

bi-hexagon UD profile

- > Acc. to DIN 3124, ISO 2725-1
- > Square drive as per DIN 3120 - D 25, ISO 1174, with locking pin
- > Hand-operated, knurled grip
- > GEDORE vanadium steel 31CrV3, chrome-plated
- \* not standardised



D 21 36



D 21 60

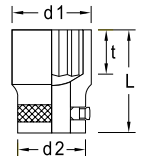

Ø mm	L	d <sub>1</sub>	d <sub>2</sub>	t		Code	No.
36	70.0	53.9	48.0	30.0	0.600	6174900	D 21 36
41	70.0	60.1	50.0	30.5	0.688	6175040	D 21 41
46	75.0	66.4	50.0	33.5	0.842	6175120	D 21 46
50	75.0	71.4	50.0	35.0	0.908	6175200	D 21 50
55	80.0	77.6	50.0	37.5	1.129	6175390	D 21 55

Ø mm	L	d <sub>1</sub>	d <sub>2</sub>	t		Code	No.
60	85.0	83.9	50.0	41.0	1.376	6175470	D 21 60
65	88.0	90.1	59.5	44.5	1.700	6175550	D 21 65
70	92.0	96.4	59.5	48.0	1.984	6175630	D 21 70
75	95.0	102.6	59.5	51.0	2.225	6175710	D 21 75
80	97.0	108.9	59.5	54.0	2.454	6175980	D 21 80

D 21 (AF)  
SOCKET 1"

bi-hexagon

- > Square drive as per DIN 3120 - D 25, ISO 1174, with locking pin
- > Hand-operated, knurled grip
- > GEDORE vanadium steel 31CrV3, chrome-plated



D 21 36



D 21 60

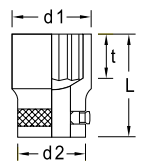

Ø AF	L	d <sub>1</sub>	d <sub>2</sub>	t		Code	No.
1.1/2	70.0	56.5	48.0	30.0	0.649	6176520	D 21 1.1/2AF
1.5/8	70.0	60.1	50.0	30.5	0.701	6176600	D 21 1.5/8AF
1.13/16	75.0	66.4	50.0	33.5	0.835	6176870	D 21 1.13/16AF
1.7/8	75.0	68.4	50.0	33.5	0.890	6176950	D 21 1.7/8AF
2	75.0	72.4	50.0	35.0	0.944	6177090	D 21 2AF
2.1/16	75.0	74.0	50.0	35.0	0.987	6177170	D 21 2.1/16AF
2.3/16	80.0	78.3	50.0	37.5	1.181	6177250	D 21 2.3/16AF
2.1/4	80.0	80.3	50.0	37.5	1.230	6177330	D 21 2.1/4AF
2.3/8	85.0	83.9	50.0	41.0	1.398	6177410	D 21 2.3/8AF

Ø AF	L	d <sub>1</sub>	d <sub>2</sub>	t		Code	No.
2.7/16	85.0	86.2	50.0	41.0	1.544	6177680	D 21 2.7/16AF
2.9/16	88.0	90.1	59.5	44.5	1.788	6177760	D 21 2.9/16AF
2.5/8	88.0	92.2	59.5	44.5	1.813	6177840	D 21 2.5/8AF
2.3/4	92.0	96.4	59.5	48.0	2.065	6177920	D 21 2.3/4AF
2.13/16	92.0	98.2	59.5	48.0	2.140	6178060	D 21 2.13/16AF
2.15/16	95.0	102.6	59.5	51.0	2.307	6178140	D 21 2.15/16AF
3	95.0	104.1	59.5	51.0	2.349	6178220	D 21 3AF
3.1/8	97.0	108.9	59.5	54.0	2.556	6178300	D 21 3.1/8AF

IN 21  
SCREWDRIVER BIT SOCKET 1"

for in-hex screws

- > Acc. to DIN 7422
- > Square drive as per DIN 3120 - D 25, ISO 1174, with locking pin
- > Hand-operated, knurled grip
- > Chrome-plated
- > With pressed-in pin in GEDORE vanadium special steel, manganese-phosphated
- \* not standardised



IN 21 17

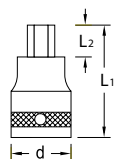

Ø mm	L <sub>1</sub>	L <sub>2</sub>	d		Code	No.
17	90	25.5	48	0.613	6181010	IN 21 17
19	90	25.5	48	0.676	6181280	IN 21 19
22	90	25.5	48	0.733	6181360	IN 21 22
24	90	25.5	48	0.784	6181440	IN 21 24
27	90	25.5	48	0.856	6200680	IN 21 27

K 21

>246



## Accessories 25 (1")

2187  
SLIDING T BAR 1"

- > Acc. to DIN 3122, ISO 3315
- > For hand-operated sockets with square drive as per DIN 3120, ISO 1174, with locking pin
- > GEDORE vanadium steel 31CrV3, chrome-plated

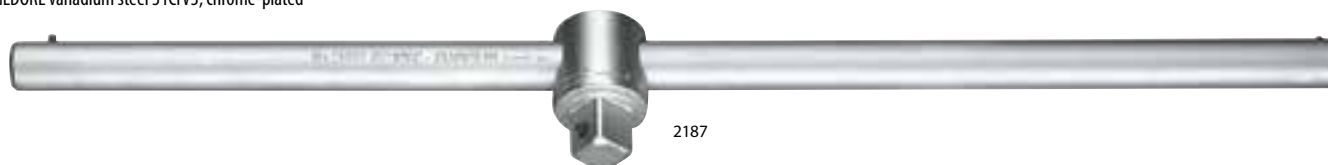

Execution	■"	■	↳ mm ↲	⚖	Code	No.
<b>complete</b>	1	25	700	3.955	6180120	2187
<b>drive piece</b>	1	25	80	0.680	6196040	2187 K
<b>tommy bar</b>			700	3.275	6195900	2187 G

2190  
EXTENSION 1"

- > Acc. to DIN 3123, ISO 3316
- > For hand-operated sockets with square drive as per DIN 3120, ISO 1174, with locking pin
- > GEDORE vanadium steel 31CrV3, chrome-plated

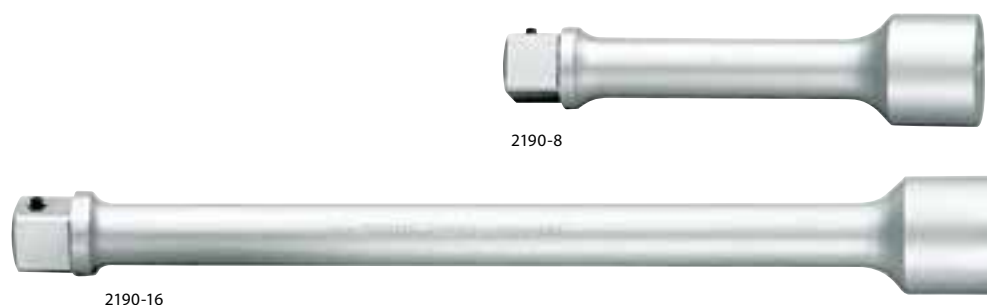

■"	■	↳ mm ↲	⚖	Code	No.
1	25	200	1.182	6180200	2190-8
1	25	400	2.144	6180390	2190-16

2194  
COUPLER 1"

- > Acc. to DIN 3122, ISO 3315
- > For hand-operated sockets with square drive as per DIN 3120, ISO 1174, with locking pin
- > GEDORE vanadium steel 31CrV3, chrome-plated



■"	■	↳ mm ↲	⚖	Code	No.
1	25	67.5	0.321	6180710	2194

2132  
REDUCER 1" TO 3/4"

- > Acc. to DIN 3123, ISO 3316
- > For hand-operated sockets with square drive as per DIN 3120, ISO 1174, with locking pin
- > GEDORE vanadium steel 31CrV3, chrome-plated

2195  
UNIVERSAL JOINT 1"

- > For hand-operated sockets with square drive as per DIN 3120, ISO 1174, with locking pin
- > GEDORE vanadium steel 31CrV3, chrome-plated



■"	■	□"	□	↳ mm ↲	⚖	Code	No.	□"	□	■"	■	↳ mm ↲	⚖	Code	No.
1	25	1	25	140	1.482	6180980	2195	1	25	3/4	20	75	0.504	6180040	2132