

10 (3/8") square drive

10 3/8 10 3/8

Sets 10 (3/8") METRIC

10 3/8

30 JMU / D 30 JMU SOCKET SET 3/8"

16 pieces

- > With forged, tempered hexagon (no. 30) or bi-hexagon (no. D 30) UD profile sockets, hand-operated
- > With accessories made from GEDORE vanadium steel 31CrV3
- > With reversible lever change ratchet
- > In GEDORE blue sheet steel case
- > Dimensions: 320 x 132 x 55 mm



10
3/8
mm

Ratchet	Sockets	Accessories	kg	Code	No.
U-10 3093 U-10	30 6 7 8 9 10 11 12 13 14 15 16 17 18 19	3090-5	2.2	2682885	30 JMU-10
U-10 3093 U-10	D 30 6 7 8 9 10 11 12 13 14 15 16 17 18 19	3090-5	2.3	2682893	D 30 JMU-10

30 HMU / D 30 HMU SOCKET SET 3/8"

22 pieces

- > With forged, tempered hexagon (no. 30) or bi-hexagon (no. D 30) UD profile sockets, hand-operated
- > With accessories made from GEDORE vanadium steel 31CrV3
- > Set U-3 with fine toothed, dial change ratchet
- > Set U-10 with reversible lever change ratchet
- > In GEDORE blue sheet steel case
- > Dimensions: 320 x 210 x 55 mm



10
3/8
mm

Ratchet	Sockets	Accessories	kg	Code	No.
U-3 3093 U-3	30 6 7 8 9 10 11 12 13 14 15 16 17 18 19 20 21 22	3087 3090-5 -10 3095	3.0	6238300	30 HMU-3
U-10 3093 U-10	30 6 7 8 9 10 11 12 13 14 15 16 17 18 19 20 21 22	3087 3090-5 -10 3095	3.0	6235470	30 HMU-10
U-3 3093 U-3	D 30 6 7 8 9 10 11 12 13 14 15 16 17 18 19 20 21 22	3087 3090-5 -10 3095	3.1	6240470	D 30 HMU-3
U-10 3093 U-10	D 30 6 7 8 9 10 11 12 13 14 15 16 17 18 19 20 21 22	3087 3090-5 -10 3095	3.1	6239700	D 30 HMU-10

30 GMU / D 30 GMU SOCKET SET 3/8"

17 pieces

- > With forged, tempered hexagon (no. 30) or bi-hexagon (no. D 30) UD profile sockets, hand-operated
- > With accessories made from GEDORE vanadium steel 31CrV3
- > Set U-3 with fine toothed, dial change ratchet
- > Set U-10 with reversible lever change ratchet
- > In GEDORE blue sheet steel case
- > Dimensions: 320 x 210 x 55 mm



10
3/8"
mm

Ratchet	Sockets	Accessories		Code	No.
U-3 3093 U-3	30 6 7 8 9 10 11 13 14 15 16 17 19	3087 3090-5 -10 3095	2.6	6235980	30 GMU-3
U-10 3093 U-10	30 6 7 8 9 10 11 13 14 15 16 17 19	3087 3090-5 -10 3095	2.6	6235710	30 GMU-10
U-3 3093 U-3	D 30 6 7 8 9 10 11 13 14 15 16 17 19	3087 3090-5 -10 3095	2.7	6240200	D 30 GMU-3
U-10 3093 U-10	D 30 6 7 8 9 10 11 13 14 15 16 17 19	3087 3090-5 -10 3095	2.7	6239380	D 30 GMU-10

30 IMU SOCKET SET 3/8"

26 pieces

- > With forged, tempered hexagon UD profile sockets, hand-operated
- > With accessories made from GEDORE vanadium steel 31CrV3
- > Set U-3 with fine toothed, dial change ratchet
- > Set U-10 with reversible lever change ratchet
- > In GEDORE blue sheet steel case
- > Dimensions: 320 x 210 x 55 mm



10
3/8"
mm

Ratchet	Sockets	Accessories		Code	No.
U-3 3093 U-3	30 6 7 8 9 10 11 12 13 14 15 16 17 19 IS 30 5,5 8 IN 30 4 5 6 8 IKS 30 2 3	3087 3090-5 -10 3095	3.1	6229900	30 IMU-3
U-10 3093 U-10	30 6 7 8 9 10 11 12 13 14 15 16 17 19 IS 30 5,5 8 IN 30 4 5 6 8 IKS 30 2 3	3087 3090-5 -10 3095	3.1	6229740	30 IMU-10

D 30 KMU-20 SOCKET SET 3/8"

40 pieces

- > With forged, tempered bi-hexagon UD profile sockets, hand-operated
- > With accessories made from GEDORE vanadium steel 31CrV3
- > With robust lever-change reversible ratchet with push-button release
- > In GEDORE blue sheet steel case
- > Dimensions: 320 x 210 x 55 mm
- > TORX® = reg. trademark of Acument Intellectual Properties, LLC. USA



10
3/8"
6.3
1/4"

mm

Ratchet	Sockets	Accessories		Code	No.
3093 U-20 3093 U-3 T	D 30 8 9 10 11 12 13 14 15 16 17 18 19 680 4 5,5 6,5 685 3 4 5 6 685 X 5 6 8 687 TX T10 T15 T20 T25 T27 T30 690 1 2 690 PZD 1 2	3090 KR-3 3090-5 630 673 10 676 699	2.6	1973347	D 30 KMU-20

D 30 TX20 U-20 SOCKET SET 3/8" + 1/4"

50 pieces

- > Tool set for general industrial and automotive applications
- > 3/8" and 1/4" sockets for protruding and recessed TORX® screws
- > With robust lever-change reversible ratchets, with push-button release
- > In sheet steel case with Check-Tool insert
- > Dimensions: 320 x 210 x 55 mm
- > TORX® = reg. trademark of Acument Intellectual Properties, LLC. USA



10
3/8"
6.3
1/4"
6.3
1/4"

mm

Ratchet	Sockets	Accessories		Code	No.
3093 U-20 2093 U-20	D 30 10 11 12 13 14 15 16 17 18 19 21 22 TX 30 E11 E12 E14 ITX 30 T45 T50 D 20 4 5 5,5 6 7 8 9 10 12 13 TX 20 E5 E6 E7 E8 E10 687 TX T10 T15 T20 T25 T27 T30 T40	3090 KR-3 3090-5 2090 KR-2 2090-6 620 673 6,3 10 676 699	3.2	2075695	D 30 TX20 U-20

IN 30 LKM SCREWDRIVER BIT SOCKET SET 3/8"

10
3/8"
mm

10 pieces

- > For in-hex screws, short and long
- > In plastic case
- > Dimensions: 200 x 120 x 38 mm



Sockets	kg	Code	No.
● IN 30 4 5 6 8 10	0.761	1509918	IN 30 LKM
● IN 30 L 4 5 6 8 10			

ITX 30 PM SCREWDRIVER BIT SOCKET SET 3/8"

10
3/8"

7 pieces

- > For recessed TORX® screws
- > In plastic case
- > Dimensions: 200 x 120 x 38 mm
- > TORX® = reg. trademark of Acument Intellectual Properties, LLC. USA



Sockets	kg	Code	No.
● ITX 30 T20 T25 T27 T30 T40 T45 T50	0.627	1509926	ITX 30 PM

ITX 30 LKP SCREWDRIVER BIT SOCKET SET 3/8"

10
3/8"

14 pieces

- > For recessed TORX® screws, short and long
- > In plastic case
- > Dimensions: 200 x 120 x 38 mm
- > TORX® = reg. trademark of Acument Intellectual Properties, LLC. USA



Sockets	kg	Code	No.
● ITX 30 T20 T25 T27 T30 T40 T45 T50	1.081	1509950	ITX 30 LKP
● ITX 30 L T20 T25 T27 T30 T40 T45 T50			

ITX 30 TX-015 SCREWDRIVER BIT SOCKET SET 3/8"

10
3/8"

15 pieces

- > For protruding and recessed TORX® screws
- > In plastic case
- > Dimensions: 200 x 120 x 38 mm
- > TORX® = reg. trademark of Acument Intellectual Properties, LLC. USA



Sockets	kg	Code	No.
● ITX 30 T20 T25 T27 T30 T40 T45 T50	0.801	1509942	ITX 30 TX-015
● TX 30 E5 E6 E7 E8 E10 E11 E12 E14			

TX 30 E-08 SOCKET SET 3/8"

10
3/8"

8 pieces

- > For protruding TORX® screws
- > In plastic case
- > Dimensions: 160 x 95 x 38 mm
- > TORX® = reg. trademark of Acument Intellectual Properties, LLC. USA



Sockets	kg	Code	No.
● TX 30 E5 E6 E7 E8 E10 E11 E12 E14	0.485	1509934	TX 30 E-08

30 TX 20 SCREWDRIVER BIT SOCKET SET 3/8" + 1/4"

6.3
1/4"
10
3/8"

28 pieces

- > 3/8" and 1/4" sockets for protruding and recessed TORX® screws
- > In plastic case
- > Dimensions: 275 x 150 x 42 mm
- > TORX® = reg. trademark of Acument Intellectual Properties, LLC. USA



Sockets	kg	Code	No.
☒ ● ITX 30 T25 T27 T30 T40 T45 T50	1.484	1509969	30 TX 20
☒ ● ITX 30 L T20 T25 T27 T30 T40 T45 T50			
☒ ● TX 30 E8 E10 E11 E12 E14			
☒ ● ITX 20 T8 T9 T10 T15 T20			
☒ ● TX 20 E4 E5 E6 E7			
☒ ☒ 2030			

Sets 10 (3/8") INCH





D 30 JAU

SOCKET SET 3/8"

12 pieces

- > With forged, tempered UD profile, hand-operated sockets
- > With accessories made from GEDORE vanadium steel 31CrV3
- > With reversible lever change ratchet
- > In GEDORE blue sheet steel case
- > Dimensions: 320 x 132 x 55 mm



Ratchet	Sockets	Accessories		Code	No.
 U-10 3093 U-10	 D 30 1/4 5/16 11/32 3/8 7/16 1/2 9/16 5/8 11/16 3/4"	 3090-5	2.0	2682907	D 30 JAU-10







D 30 GAU

SOCKET SET 3/8"

17 pieces

- > With forged, tempered UD profile, hand-operated sockets
- > With accessories made from GEDORE vanadium steel 31CrV3
- > With reversible lever change ratchet
- > In GEDORE blue sheet steel case
- > Dimensions: 320 x 210 x 55 mm



Ratchet	Sockets	Accessories		Code	No.
 U-10 3093 U-10	 D 30 1/4 9/32 5/16 11/32 3/8 7/16 1/2 9/16 19/32 5/8 11/16 3/4"	 3087  3090-5 -10  3095	2.6	6239540	D 30 GAU-10

Ratchets 10 (3/8")

3093 U-20 REVERSIBLE RATCHET 3/8"

- > Used throughout industry and the automotive world - and as well in confined spaces
- > Acc. to DIN 3122, ISO 3315
- > Small, drop shaped head for confined areas
- > Fine-toothed (60 teeth), with lever change and push-button release
- > Return angle 6 degrees
- > Non-slip 2-component handle with hanging hole
- > For hand-operated sockets and accessories with square drive as per DIN 3120 - C 10, ISO 1174, ball locking device
- > GEDORE vanadium steel 31CrV3, chrome-plated

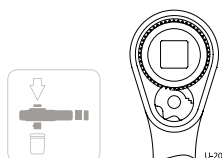

"	mm	°	mm	mm	kg	Code	No.
3/8	10	6	200	29.7	0.292	1556800	3093 U-20

3093 U-10 REVERSIBLE RATCHET 3/8"

- > Particularly for the demanding use experienced in industry and with utility vehicles
- > Acc. to DIN 3122, ISO 3315
- > With recessed lever change
- > Locks in the middle position: When the lever is flipped, it automatically engages for clockwise or counterclockwise operation
- > Push-button release
- > Return angle 11.25 degrees
- > Non-slip 2-component handle with hanging hole
- > For hand-operated sockets and accessories with square drive as per DIN 3120 - C 10, ISO 1174, ball locking device
- > GEDORE vanadium steel 31CrV3, chrome-plated

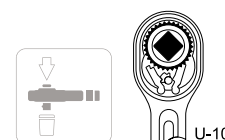

"	mm	°	mm	mm	kg	Code	No.
3/8	10	11,25	200	30.2	0.254	6236950	3093 U-10

3093 ALU-10 ALUMINIUM REVERSIBLE RATCHET 3/8"

- > Very lightweight, especially for work done above your head
- > Design spec. similar to DIN 3122, ISO 3315
- > Made from special-purpose drop-forged and hardened aluminium
- > The mechanism as in all U-10 ratchets is made from high quality steel
- > With recessed lever change
- > Locks in the middle position: When the lever is flipped, it automatically engages for clockwise or counterclockwise operation
- > Push-button release
- > Return angle 11.25 degrees
- > Non-slip 2-component handle with hanging hole
- > For hand-operated sockets and accessories with square drive as per DIN 3120 - C 10, ISO 1174, ball locking device
- > Extremely lightweight - just 160 g



"	mm	°	mm	mm	kg	Code	No.
3/8	10	11,25	200	30.2	0.160	1900005	3093 ALU-10

3093 U-3 REVERSIBLE RATCHET 3/8"

- > Especially for working in confined spaces, as in the automotive business
- > Acc. to DIN 3122, ISO 3315
- > With non-slip metal disc change, fine-toothed (72 teeth) and robust
- > Return angle 5 degrees
- > Non-slip 2-component handle with hanging hole
- > For hand-operated sockets and accessories with square drive as per DIN 3120 - C 10, ISO 1174, ball locking device
- > GEDORE vanadium steel 31CrV3, chrome-plated

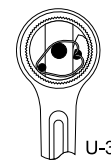

"	mm	°	mm	mm	kg	Code	No.
3/8	10	5	200	33.5	0.244	6237090	3093 U-3



3093 GU-3 SWIVEL HEAD REVERSIBLE RATCHET 3/8"

- › Especially for use in the automotive sector
- › Swivels through 180°, with joint lock
- › With non-slip metal disc change, fine-toothed (72 teeth) and robust
- › Return angle 5 degrees
- › Non-slip 2-component handle with hanging hole
- › Max. torque 200 N-m
- › For hand-operated sockets and accessories with square drive as per DIN 3120 - C 10, ISO 1174, ball locking device
- › GEDORE vanadium steel 31CrV3, chrome-plated



"	mm	°	mm	mm	kg	Code	No.
3/8	10	5	282	33.5	0.525	6237170	3093 GU-3

3093 Z-94 RATCHET HANDLE WITH COUPLER 3/8"

- › Used throughout industry and the automotive world
- › Acc. to DIN 3122, ISO 3315
- › With square coupler, medium-fine toothed, extremely rugged
- › Return angle 10 degrees
- › Non-slip 2-component handle with hanging hole
- › For hand-operated sockets and accessories with square drive as per DIN 3120 - C 10, ISO 1174, ball locking device
- › GEDORE vanadium steel 31CrV3, chrome-plated



"	mm	°	mm	mm	kg	Code	No.
3/8	10	10	200	18	0.223	6237680	3093 Z-94

VDE 3093 U

›573



3093 U-3 T RATCHET WITH T-HANDLE 3/8"

- › For progressing fast in confined spaces
- › Two-wing T-handle
- › Return angle 5 degrees
- › Ergonomic design for comfortable working
- › For hand-operated sockets and accessories with square drive as per DIN 3120 - C 10, ISO 1174, ball locking device
- › The danger of the tool canting, when carrying out work with extensions, is reduced by the central positioning of the square drive



"	mm	°	mm	kg	Code	No.
3/8	10	5	140	0.068	1973320	3093 U-3 T

Sockets 10 (3/8")

30 (MM) SOCKET 3/8"

hexagon UD profile

- > Acc. to DIN 3124, ISO 2725-1
 - > Square drive as per DIN 3120 - C 10, ISO 1174, with ball retention groove
 - > Hand-operated, knurled grip
 - > GEDORE vanadium steel 31CrV3, polished, chrome-plated
- * not standardised

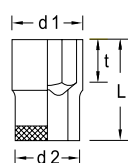

Ø mm	L	d ₁	d ₂	t		Code	No.	
6	*	28	9.7	17.5	5.0	0.024	6230160	30 6
7		28	11.0	17.5	5.0	0.024	6230240	30 7
8		28	12.1	17.5	9.0	0.028	6230320	30 8
9		28	13.5	17.5	9.0	0.027	6230400	30 9
10		28	14.7	17.5	9.0	0.028	6230590	30 10
11		28	16.0	17.5	9.0	0.030	6233850	30 11
12		28	17.2	18.3	9.0	0.033	6233930	30 12
13		28	18.5	17.5	9.0	0.032	6234070	30 13
14		29	19.7	18.4	11.0	0.038	6234150	30 14
15		30	21.0	19.7	12.5	0.044	6234230	30 15
16		30	22.2	21.0	12.5	0.049	6234310	30 16
17		30	23.5	22.3	12.5	0.057	6234580	30 17
18		30	24.7	23.0	12.5	0.062	6234660	30 18
19		30	26.0	23.7	12.5	0.068	6234740	30 19
20		31	27.2	24.5	12.5	0.078	6234820	30 20
21		31	28.5	25.8	13.5	0.086	6234900	30 21
22		32	29.7	26.3	14.5	0.092	6235040	30 22
24	*	33	32.0	28.0	15.5	0.120	2194783	30 24

30 (AF) SOCKET 3/8"

hexagon UD profile

- > Square drive as per DIN 3120 - C 10, ISO 1174, with ball retention groove
- > Hand-operated, knurled grip
- > GEDORE vanadium steel 31CrV3, polished, chrome-plated

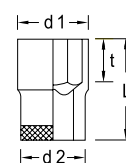

Ø AF	L	d ₁	d ₂	t		Code	No.
1/4	28	10.1	17.5	5.0	0.023	6232100	30 1/4AF
5/16	28	12.1	17.5	9.0	0.025	6232370	30 5/16AF
11/32	28	13.1	17.5	9.0	0.025	6232450	30 11/32AF
3/8	28	14.1	17.5	9.0	0.026	6232530	30 3/8AF
7/16	28	16.1	17.5	9.0	0.028	2101025	30 7/16AF
1/2	28	18.1	19.2	9.0	0.035	2101033	30 1/2AF
9/16	29	20.1	18.7	11.0	0.039	2101041	30 9/16AF
19/32	30	21.0	19.7	12.5	0.044	2101068	30 19/32AF
5/8	30	22.1	20.7	12.5	0.048	2101076	30 5/8AF
11/16	30	24.0	22.7	12.5	0.060	2101084	30 11/16AF
3/4	30	26.0	23.7	12.5	0.065	2101092	30 3/4AF
7/8	32	30.0	26.5	14.5	0.120	2101106	30 7/8AF

VDE 30

>573



D 30 (MM) SOCKET 3/8"



bi-hexagon UD profile

- > Acc. to DIN 3124, ISO 2725-1
 - > Square drive as per DIN 3120 - C 10, ISO 1174, with ball retention groove
 - > Hand-operated, knurled grip
 - > GEDORE vanadium steel 31CrV3, polished, chrome-plated
- * not standardised



D 30 10

D 30 22

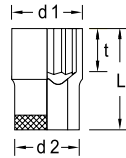

Ø mm	L	d ₁	d ₂	t		Code	No.
6	28	9.7	17.5	5.0	0.111	1845705	D 30 6
7	28	11.0	17.5	5.0	0.024	1845713	D 30 7
8	28	12.1	17.5	9.0	0.026	1845721	D 30 8
9	28	13.5	17.5	9.0	0.027	1845748	D 30 9
10	28	14.7	17.5	9.0	0.028	6229230	D 30 10
11	28	16.0	17.5	9.0	0.030	6230670	D 30 11
12	28	17.2	18.3	9.0	0.032	6230750	D 30 12
13	28	18.5	17.5	9.0	0.031	6230830	D 30 13
14	29	19.7	18.4	11.0	0.037	6230910	D 30 14
15	30	21.0	19.7	12.5	0.040	6231050	D 30 15
16	30	22.2	21.0	12.5	0.049	6231130	D 30 16
17	30	23.5	22.3	12.5	0.054	6231210	D 30 17
18	30	24.7	23.0	12.5	0.062	6231480	D 30 18
19	30	26.0	23.7	12.5	0.064	6231560	D 30 19
20	31	27.2	24.5	12.5	0.074	6231640	D 30 20
21	31	28.5	25.8	13.5	0.083	6231720	D 30 21
22	32	29.7	26.3	14.5	0.087	6231800	D 30 22
24	33	32.0	28.0	15.5	0.100	2194864	D 30 24

D 30 (AF) SOCKET 3/8"



bi-hexagon UD profile

- > Square drive as per DIN 3120 - C 10, ISO 1174, with ball retention groove
- > Hand-operated, knurled grip
- > GEDORE vanadium steel 31CrV3, polished, chrome-plated



D 30 10

D 30 22

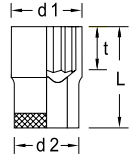

Ø "AF	L	d ₁	d ₂	t		Code	No.
1/4	28	10.1	17.5	5.0	0.050	2016613	D 30 1/4AF
9/32	28	11.1	17.5	5.0	0.020	2101009	D 30 9/32AF
5/16	28	12.1	17.5	5.0	0.020	1997122	D 30 5/16AF
11/32	28	13.1	17.5	9.0	0.026	2101017	D 30 11/32AF
3/8	28	14.1	17.5	9.0	0.010	1997130	D 30 3/8AF
13/32	28	15.0	17.5	9.0	0.030	1997149	D 30 13/32AF
7/16	28	16.1	17.5	9.0	0.027	6232610	D 30 7/16AF
1/2	28	18.1	19.2	9.0	0.034	6232880	D 30 1/2AF
9/16	29	20.1	18.7	11.0	0.036	6232960	D 30 9/16AF
19/32	30	21.0	19.7	12.5	0.039	6233180	D 30 19/32AF
5/8	30	22.1	20.7	12.5	0.044	6233260	D 30 5/8AF
11/16	30	24.0	22.7	12.5	0.053	6233340	D 30 11/16AF
3/4	30	26.0	23.7	12.5	0.061	6233420	D 30 3/4AF
25/32	31	27.0	24.3	12.5	0.075	1997157	D 30 25/32AF
13/16	31	28.0	25.3	12.5	0.080	1997165	D 30 13/16AF
7/8	32	30.0	26.5	14.5	0.082	6232020	D 30 7/8AF
15/16	33	31.9	28.0	15.5	0.110	1997173	D 30 15/16AF
1	33	33.9	30.0	15.5	0.120	1983296	D 30 1AF

D 30 L (MM) SOCKET 3/8"



bi-hexagon UD profile, long pattern

- > Acc. to DIN 3124, ISO 2725-1
- > Square drive as per DIN 3120 - C 10, ISO 1174, with ball retaining groove
- > Hand-operated, knurled grip
- > GEDORE vanadium steel 31CrV3, polished, chrome-plated



D 30 L 10

D 30 L 22

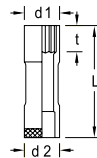

Ø mm	L	d ₁	d ₂	t		Code	No.
10	63.5	14.7	17.5	11	0.053	6258330	D 30 L 10
11	63.5	16.0	17.5	12	0.054	6258410	D 30 L 11
12	63.5	17.2	17.5	14	0.059	6258680	D 30 L 12
13	63.5	18.5	19.0	14	0.070	6258760	D 30 L 13
14	63.5	19.7	19.5	17	0.076	6258840	D 30 L 14
15	63.5	21.0	20.5	17	0.095	6258920	D 30 L 15
16	63.5	22.2	22.0	17	0.085	6259060	D 30 L 16
17	63.5	23.5	20.5	17	0.096	6259140	D 30 L 17
18	63.5	24.7	21.5	20	0.113	6259220	D 30 L 18
19	63.5	26.0	22.0	20	0.124	6259300	D 30 L 19
20	63.5	27.2	23.5	20	0.127	6259490	D 30 L 20
21	63.5	28.5	23.5	20	0.134	6259570	D 30 L 21
22	63.5	29.7	23.5	23	0.136	6259650	D 30 L 22

D 30 L (AF) SOCKET 3/8"



bi-hexagon UD profile, long pattern

- > Square drive as per DIN 3120 - C 10, ISO 1174, with ball retaining groove
- > Hand-operated, knurled grip
- > GEDORE vanadium steel 31CrV3, polished, chrome-plated



D 30 L 10

D 30 L 22

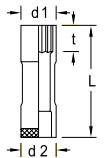

Ø "AF	L	d ₁	d ₂	t		Code	No.
3/8	63.5	14.1	17.5	11	0.051	6259730	D 30 L 3/8AF
7/16	63.5	16.1	17.5	12	0.053	6259810	D 30 L 7/16AF
1/2	63.5	18.1	19.0	14	0.065	6260070	D 30 L 1/2AF
9/16	63.5	20.1	19.5	17	0.073	6260150	D 30 L 9/16AF
5/8	63.5	22.1	22.0	17	0.092	6260230	D 30 L 5/8AF
11/16	63.5	24.0	20.5	17	0.090	6260310	D 30 L 11/16AF
3/4	63.5	26.0	22.0	20	0.109	6260580	D 30 L 3/4AF
13/16	63.5	28.3	23.5	20	0.132	6260660	D 30 L 13/16AF
7/8	63.5	30.0	23.5	23	0.134	6260740	D 30 L 7/8AF

DG 30 SWIVEL SOCKET 3/8"

bi-hexagon UD profile

- > Square drive as per DIN 3120 - C 10, ISO 1174, with ball retaining groove
- > Hand-operated
- > Chrome-vanadium steel 31CrV3, chrome-plated

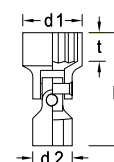

Ø mm	L	d ₁	d ₂	t		Code	No.
10	41.5	14.7	19	8.0	0.042	6240630	DG 30 10
13	42.5	18.5	19	9.0	0.050	6241520	DG 30 13
14	43.5	19.7	19	10.0	0.054	6241600	DG 30 14
15	45.5	21.0	19	11.0	0.048	6241790	DG 30 15
17	46.0	23.5	19	12.0	0.061	6241950	DG 30 17
18	46.0	24.7	19	12.5	0.063	6242410	DG 30 18
19	46.5	26.0	19	12.5	0.064	6242680	DG 30 19

TX 30 SOCKET 3/8"

for protruding TORX® head screws

- > Square drive as per DIN 3120 - C 10, ISO 1174, with ball retaining groove
- > Hand-operated, knurled grip
- > GEDORE vanadium steel 31CrV3, polished, chrome-plated
- > TORX® = reg. trademark of Acument Intellectual Properties, LLC. USA

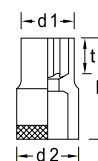

⊙	M	★ mm	L	d ₁	d ₂	t		Code	No.
E5	M4	4,73	28	7.2	17.5	5.0	0.025	6250270	TX 30 E5
E6	M5	5,74	28	8.5	17.5	5.0	0.025	6250350	TX 30 E6
E7	M6	6,16	28	9.5	17.5	5.5	0.025	6250430	TX 30 E7
E8	M6 - M7	7,52	28	10.8	17.5	6.0	0.027	6250510	TX 30 E8
E10	M8	9,42	28	13.2	17.5	9.0	0.029	6250780	TX 30 E10
E11	-	10,08	28	13.8	17.5	9.0	0.030	6250860	TX 30 E11
E12	M10	11,17	28	15.2	17.5	9.0	0.032	6250940	TX 30 E12
E14	M12	12,90	28	16.8	18.3	9.0	0.035	6251080	TX 30 E14

1500 ES-ITX 30

> 100



ITX 30 SCREWDRIVER BIT SOCKET 3/8"

10
3/8"

for recessed TORX® head screws

- > Square drive as per DIN 3120 - C 10, ISO 1174, with ball retaining groove
- > Hand-operated, knurled grip
- > Chrome-plated
- > With pressed-in pin in GEDORE vanadium special steel, gun-metal finish
- > TORX® = reg. trademark of Acument Intellectual Properties, LLC. USA

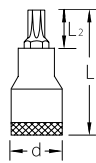

⊕	M	mm	L ₁	L ₂	d	kg	Code	No.
T20	M4 - M5	3,86	49	17	17.5	0.050	6246320	ITX 30 T20
T25	M4,5 - M5	4,43	49	17	17.5	0.051	6246830	ITX 30 T25
T27	M4,5 - M6	4,99	49	17	17.5	0.051	6247210	ITX 30 T27
T30	M6 - M7	5,52	49	17	17.5	0.051	6247560	ITX 30 T30
T40	M7 - M8	6,65	49	17	17.5	0.052	6247720	ITX 30 T40
T45	M8 - M10	7,82	49	17	17.5	0.053	6247800	ITX 30 T45
T50	M10	8,83	49	17	19.0	0.070	6247990	ITX 30 T50

ITX 30 L SCREWDRIVER BIT SOCKET 3/8"

10
3/8"

for recessed TORX® head screws, long pattern

- > Square drive as per DIN 3120 - C 10, ISO 1174, with ball retaining groove
- > Hand-operated, knurled grip
- > Chrome-plated
- > With pressed-in pin in GEDORE vanadium special steel, gun-metal finish
- > TORX® = reg. trademark of Acument Intellectual Properties, LLC. USA

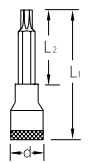

⊕	M	mm	L ₁	L ₂	d	kg	Code	No.
T20	M4 - M5	3,86	94	62	17.5	0.070	1394177	ITX 30 L T20
T25	M4,5 - M5	4,43	94	62	17.5	0.070	1394185	ITX 30 L T25
T27	M4,5 - M6	4,99	94	62	17.5	0.070	1394193	ITX 30 L T27
T30	M6 - M7	5,52	94	62	17.5	0.071	1394207	ITX 30 L T30
T40	M7 - M8	6,65	94	62	17.5	0.070	1394215	ITX 30 L T40
T45	M8 - M10	7,82	94	62	17.5	0.071	1394223	ITX 30 L T45
T50	M10	8,83	94	62	19.0	0.099	1394231	ITX 30 L T50

ITX 30 B SCREWDRIVER BIT SOCKET 3/8"

10
3/8"

for recessed TORX® head screws with pilot

- > Square drive as per DIN 3120 - C 10, ISO 1174, with ball retaining groove
- > Hand-operated, knurled grip
- > Chrome-plated
- > With pressed-in pin in GEDORE vanadium special steel, gun-metal finish
- > TORX® = reg. trademark of Acument Intellectual Properties, LLC. USA

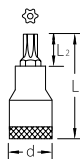

⊕	M	mm	L ₁	L ₂	d	Bore mm	kg	Code	No.
T20	M4 - M5	3,86	49	17	17.5	1,55 x 1,86	0.046	1440969	ITX 30 B T20
T25	M4,5 - M5	4,43	49	17	17.5	1,93 x 2,04	0.048	1440977	ITX 30 B T25
T27	M4,5 - M6	4,99	49	17	17.5	2,18 x 2,29	0.048	1440985	ITX 30 B T27
T30	M6 - M7	5,52	49	17	17.5	2,56 x 2,92	0.048	1440993	ITX 30 B T30
T40	M7 - M8	6,65	49	17	19.0	2,92 x 3,28	0.064	1429701	ITX 30 B T40
T45	M8 - M10	7,82	49	17	19.0	3,45 x 3,68	0.066	1441000	ITX 30 B T45
T50	M10	8,83	49	17	20.5	3,83 x 3,78	0.078	1441019	ITX 30 B T50

IS 30 SCREWDRIVER BIT SOCKET 3/8"

10
3/8"

for slotted head screws

- > Square drive as per DIN 3120 - C 10, ISO 1174, with ball retaining groove
- > Hand-operated, knurled grip
- > Chrome-plated
- > With pressed-in pin in GEDORE vanadium special steel, manganese-phosphated
- > Blade as per DIN ISO 2380-1, Form B

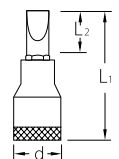

⊖	mm	mm	L ₁	L ₂	d	kg	Code	No.
5.5	1.0	55	27	17.5	0.040	6666100	IS 30 5,5x1	
6.5	1.2	55	27	17.5	0.039	1640895	IS 30 6,5x1,2	
8.0	1.2	55	23	17.5	0.054	6666290	IS 30 8x1,2	
10.0	1.6	55	23	19.0	0.072	6666370	IS 30 10x1,6	
12.0	2.0	55	23	20.5	0.083	1640909	IS 30 12x2	

IKS 30 SCREWDRIVER BIT SOCKET 3/8"

10
3/8"

for cross-head screws PH

- > Square drive as per DIN 3120 - C 10, ISO 1174, with ball retaining groove
- > Hand-operated, knurled grip
- > Chrome-plated
- > With pressed-in pin in GEDORE vanadium special steel, gun-metal finish
- > Tip as per DIN ISO 8764-1 PH

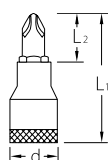

⊕ PH	L ₁	L ₂	d		Code	No.
1	55	27	17.5	0.041	6666610	IKS 30 1
2	55	23	17.5	0.052	6666880	IKS 30 2
3	55	23	19.0	0.070	6666960	IKS 30 3

IKS 30 PZD SCREWDRIVER BIT SOCKET 3/8"

10
3/8"

for cross-head screws Pozi PZ

- > Square drive as per DIN 3120 - C 10, ISO 1174, with ball retaining groove
- > Hand-operated, knurled grip
- > Chrome-plated
- > With pressed-in pin in GEDORE vanadium special steel, gun-metal finish
- > Tip as per DIN ISO 8764-1 PZ

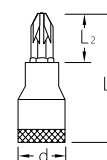

⊕ PZ	L ₁	L ₂	d		Code	No.
1	55	27	17.5	0.040	1640968	IKS 30 PZD 1
2	55	23	17.5	0.051	1640976	IKS 30 PZD 2
3	55	23	19.0	0.069	1640984	IKS 30 PZD 3

IN 30 (MM) SCREWDRIVER BIT SOCKET 3/8"

10
3/8"

for in-hex screws

- > Acc. to DIN 7422
 - > Square drive as per DIN 3120 - C 10, ISO 1174, with ball retaining groove
 - > Hand-operated, knurled grip
 - > Chrome-plated
 - > With pressed-in pin in GEDORE vanadium special steel, manganese-phosphated
- * not standardised

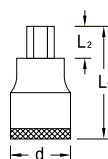
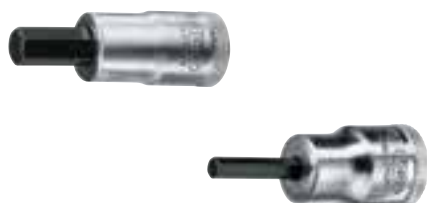

● mm	L ₁	L ₂	d		Code	No.
4	47	19	17.5	0.038	6241010	IN 30 4
5	47	19	17.5	0.039	6241280	IN 30 5
6	47	19	17.5	0.041	6241360	IN 30 6
7	*	47	17.5	0.041	1643037	IN 30 7
8	49	17	17.5	0.053	6241440	IN 30 8
10	49	17	19.0	0.073	6242920	IN 30 10

IN 30 (AF) SCREWDRIVER BIT SOCKET 3/8"

10
3/8"

for in-hex screws

- > Square drive as per DIN 3120 - C 10, ISO 1174, with ball retaining groove
- > Hand-operated, knurled grip
- > Chrome-plated
- > With pressed-in pin in GEDORE vanadium special steel, manganese-phosphated

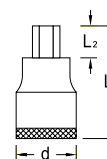

● AF	L ₁	L ₂	d		Code	No.
1/8	47	19	17.5	0.035	2195208	IN 30 1/8AF
5/32	47	19	17.5	0.040	2195232	IN 30 5/32AF
3/16	47	19	17.5	0.040	2195267	IN 30 3/16AF
1/4	47	19	17.5	0.049	1193422	IN 30 1/4AF
5/16	49	17	17.5	0.054	1193431	IN 30 5/16AF
3/8	49	17	19.0	0.050	1193449	IN 30 3/8AF

IN 30 L SCREWDRIVER BIT SOCKET 3/8"

10
3/8"

for in-hex screws, long pattern

- > Acc. to DIN 7422
- > Square drive as per DIN 3120 - C 10, ISO 1174, with ball retaining groove
- > Hand-operated, knurled grip
- > Chrome-plated
- > With pressed-in pin in GEDORE vanadium special steel, manganese-phosphated

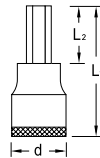

● mm	L ₁	L ₂	d	⚖ kg	Code	No.
4	95	67	17.5	0.044	1510118	IN 30 L 4-95
5	95	67	17.5	0.048	1394347	IN 30 L 5-95
6	95	67	17.5	0.053	1394355	IN 30 L 6-95
7	95	67	17.5	0.058	1394363	IN 30 L 7-95
8	95	63	17.5	0.074	1394371	IN 30 L 8-95
10	95	63	19.0	0.105	1394398	IN 30 L 10-95

IN 30 LK SCREWDRIVER BIT SOCKET 3/8"

10
3/8"

with ball end, for in-hex screws, long pattern

- > Square drive as per DIN 3120 - C 10, ISO 1174, with ball retaining groove
- > Hand-operated, knurled grip
- > Chrome-plated
- > With pressed-in pin in GEDORE vanadium special steel, gun-metal finish
- > Total swivel angle approx. 15-20°

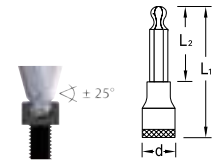

● mm	L ₁	L ₂	d	⚖ kg	Code	No.
4	132	104	17.5	0.048	1505718	IN 30 LK 4
5	132	104	17.5	0.054	1505726	IN 30 LK 5
6	132	104	17.5	0.061	1505742	IN 30 LK 6
8	134	102	17.5	0.091	1505750	IN 30 LK 8
10	134	102	19.0	0.130	1505769	IN 30 LK 10

INX 30 SCREWDRIVER BIT SOCKET 3/8"

10
3/8"

for multi-point screws XZN

- > Acc. to DIN 2324
- > Square drive as per DIN 3120 - C 10, ISO 1174, with ball retaining groove
- > Hand-operated, knurled grip
- > Chrome-plated
- > With pressed-in pin in GEDORE vanadium special steel, manganese-phosphated
- > Tip as per DIN 2325

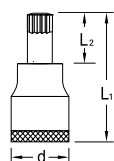

● mm	L ₁	L ₂	d	⚖ kg	Code	No.
M5	49	17	17.5	0.050	6242170	INX 30 5
M6	49	17	17.5	0.051	6242250	INX 30 6
M8	49	17	17.5	0.053	6242330	INX 30 8
M10	49	17	19.0	0.078	2194872	INX 30 10

INX 30 L SCREWDRIVER BIT SOCKET 3/8"

10
3/8"

for multi-point screws XZN, long pattern

- > Acc. to DIN 2324
- > Square drive as per DIN 3120 - C 10, ISO 1174, with ball retaining groove
- > Hand-operated, knurled grip
- > Chrome-plated
- > With pressed-in pin in GEDORE vanadium special steel, manganese-phosphated
- > Tip as per DIN 2325

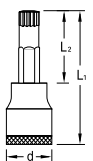

● mm	L ₁	L ₂	d	⚖ kg	Code	No.
M6	94	62	17.5	0.068	1394312	INX 30 L 6
M8	94	62	17.5	0.071	1394320	INX 30 L 8
M10	94	62	19.0	0.079	1394339	INX 30 L 10

Accessories 10 (3/8")

3084 SPEED BRACE 3/8"

- > Acc. to DIN 3122, ISO 3315
- > For hand-operated sockets and accessories with square drive as per DIN 3120, ISO 1174, with ball locking device
- > GEDORE vanadium steel 31CrV3, polished, chrome-plated
- > No. 3084 L for applications e.g. in the aviation sector



"	■	↳ mm ↳	⚖ kg	Code	No.
3/8	10	288	0.423	6236440	3084
3/8	10	463	0.568	1965395	3084 L

3098 SWIVEL HANDLE 3/8"

- > For hand-operated sockets and accessories with square drive as per DIN 3120, ISO 1174, with ball locking device
- > GEDORE vanadium steel 31CrV3, polished, chrome-plated

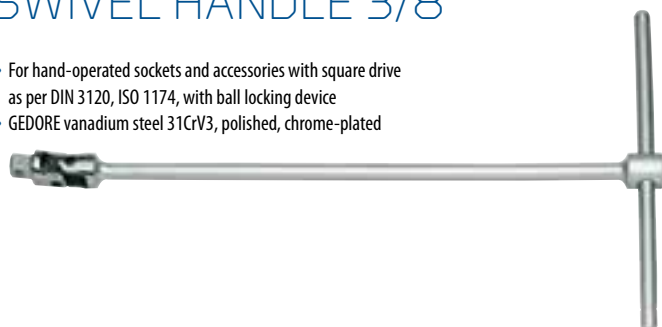

"	■	↳ mm ↳	⚖ kg	Code	No.
3/8	10	450	0.364	6182410	3098

3096 SWIVEL HANDLE 3/8"

- > Acc. to DIN 3122, ISO 3315
- > For hand-operated sockets and accessories with square drive as per DIN 3120, ISO 1174, with ball locking device
- > GEDORE vanadium steel 31CrV3, polished, chrome-plated



"	■	↳ mm ↳	⚖ kg	Code	No.
3/8	10	254	0.201	6238220	3096

3087 A SLIDING T BAR WITH RELEASE 3/8"

- > Secured against unintentional removal
- > GEDORE vanadium steel 31CrV3, polished, chrome-plated
- > Turn handle for easy locking and releasing
- > Accidental release when working is prevented because of the asymmetrical release point
- > Particularly useful for work in sensitive areas where certainty against loss is a theme
- > Examples: Aircraft engine, work in deep machine bodies
- > DBGM (German utility patent)



"	■	↳ mm ↳	⚖ kg	Code	No.
3/8	10	163	0.135	1871633	3087 A

3087 SLIDING T BAR 3/8"

- > Acc. to DIN 3122, ISO 3315
- > For hand-operated sockets and accessories with square drive as per DIN 3120, ISO 1174, with ball locking device
- > GEDORE vanadium steel 31CrV3, polished, chrome-plated



"	■	↳ mm ↳	⚖ kg	Code	No.
3/8	10	163	0.164	6236520	3087

3081 L-HANDLE 3/8"

- > Acc. to DIN 3122, ISO 3315
- > For hand-operated sockets and accessories with square drive as per DIN 3120, ISO 1174, with ball locking device
- > GEDORE vanadium steel 31CrV3, polished, chrome-plated



■ "	■	l- mm -l	⚖ kg	Code	No.
3/8	10	180	0.153	6236360	3081

3090 A EXTENSION 3/8"

with release

- > Easy access to deep-fitting screws in confined areas
- > No unintentional release of the socket from the extension due to safety ring
- > For hand-operated sockets and accessories with square drive as per DIN 3120, ISO 1174, with ball locking device



■ "	■	l- mm -l	⚖ kg	Code	No.
3/8	10	125	0.120	1932314	3090 A-5
3/8	10	250	0.210	1932322	3090 A-10

3090 M EXTENSION 3/8"

with magnet

- > For hand-operated sockets with square drive as per DIN 3120, ISO 1174, with ball locking device
- > The holding magnet securely fixes the screws or nuts in the socket
- > One-hand operation - using the socket the screw or nut can be immediately screwed in
- > Thanks to a spring mechanism the holding magnet is always in direct contact with the screw head. It ensures that the screw is centrally guided
- > A strong permanent magnet keeps hold of even large screws
- > Makes work easier particularly in confined spaces
- > Hot forged
- > GEDORE vanadium steel 31CrV3, polished



■ "	■	l- mm -l	⚖ kg	Code	No.
3/8	10	65	0.065	2960060	3090 M

3090 EXTENSION 3/8"

- > Acc. to DIN 3123, ISO 3316
- > For hand-operated sockets and accessories with square drive as per DIN 3120, ISO 1174, with ball locking device
- > GEDORE vanadium steel 31CrV3, polished, chrome-plated
- * not standardised

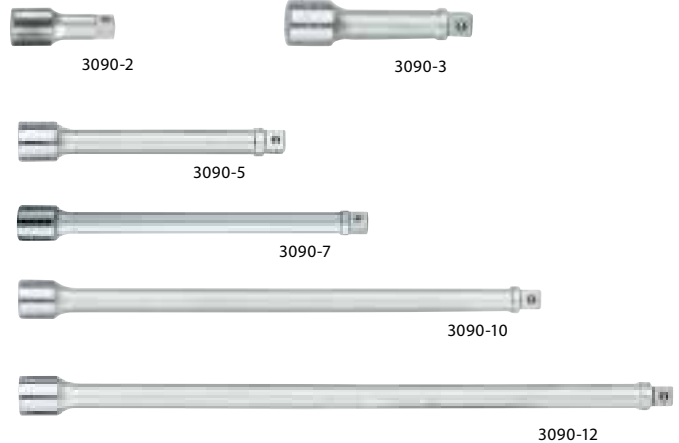

■ "	■	l- mm -l	⚖ kg	Code	No.
3/8	10	*	0.063	1476637	3090-2
3/8	10	76	0.093	6236600	3090-3
3/8	10	125	0.117	6236790	3090-5
3/8	10	*	0.164	1476645	3090-7
3/8	10	250	0.222	6236870	3090-10
3/8	10	*	0.287	6238570	3090-12
3/8	10	*	0.524	1476653	3090-20

3090 KR UNIVERSAL EXTENSION 3/8"

- > With ball end
- > For hand-operated sockets with square drive as per DIN 3120, ISO 1174, with ball locking device
- > The extension is able to pivot up to 15°
- > GEDORE vanadium steel 31CrV3, polished, chrome-plated

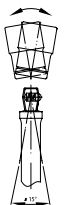

■ "	■	l- mm -l	⚖ kg	Code	No.
3/8	10	76	0.080	1874381	3090 KR-3
3/8	10	125	0.108	1845756	3090 KR-5
3/8	10	250	0.197	1845764	3090 KR-10

VDE 3090

>573



3095 UNIVERSAL JOINT 3/8"

- > Acc. to DIN 3123, ISO 3316
- > For hand-operated sockets and accessories with square drive as per DIN 3120, ISO 1174, with ball locking device

- > GEDORE vanadium steel 31CrV3, polished, chrome-plated



□"	■	□"	□	↳ mm ▷	⚖	Code	No.
3/8	10	3/8	10	50	0.053	6238140	3095

3094 COUPLER 3/8"

- > Acc. to DIN 3122, ISO 3316
- > For hand-operated sockets and accessories with square drive as per DIN 3120, ISO 1174, with ball locking device

- > GEDORE vanadium steel 31CrV3, polished, chrome-plated



□"	■	↳ mm ▷	⚖	Code	No.
3/8	10	29	0.020	6237760	3094

3019 CONVERTOR 3/8" TO 1/2"

- > Acc. to DIN 3123, ISO 3316
- > For hand-operated sockets and accessories with square drive as per DIN 3120, ISO 1174, with ball locking device

- > GEDORE vanadium steel 31CrV3, polished, chrome-plated



□"	□	□"	■	↳ mm ▷	⚖	Code	No.
3/8	10	1/2	12.5	35	0.053	6236010	3019

3020 REDUCER 3/8" TO 1/4"

- > Acc. to DIN 3123, ISO 3316
- > For hand-operated sockets and accessories with square drive as per DIN 3120, ISO 1174, with ball locking device

- > GEDORE vanadium steel 31CrV3, polished, chrome-plated



□"	□	□"	■	↳ mm ▷	⚖	Code	No.
3/8	10	1/4	6.3	28	0.026	6236280	3020

SL 3014 TOOL HOLDING RAIL, MAGNETIC 3/8"

empty

- > External squares to take 14 standard commercial 10 mm (3/8") sockets
- > Two female square adaptors to take ratchets, sliding T bars, extensions etc.
- > A strong magnet securely holds the socket rail to ferrous metals
- > Additional holes are provided for wall mounting the socket rail or attaching to non-ferrous materials
- > The sockets are securely locked by the ball at the square-drive end by turning them 90°

- > It is a simple matter to "unlock" and remove the sockets, by turning them 90° in the opposing direction
- > Delivery without tools

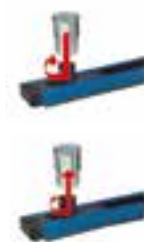

↳ mm ▷	mm	⚖	Code	No.
380	33	0.355	1761080	SL 2013



VH 30 SPRING STEEL SOCKET RAIL 3/8"

- > For 14 3/8" sockets
- > Delivery without tools



↳ mm ▷	⚖	Code	No.
405	0.067	5164810	VH 30

